

# BUILDING UPDATE

ISSUE: 623 Sept/Oct | [www.solutionspublishing.co.uk](http://www.solutionspublishing.co.uk)



## Housing Warranties

Build-Zone has been providing **Housing Warranties** and **Commercial Latent Defects Insurance** since 2003 backed by 'A' rated Insurers and approved by Lenders. A fresh and flexible approach to Structural Warranty for New Home Developments no matter how large or small, including:

- New Home Development
- Commercial/ Mixed use Development
- Social Housing
- Commercial Projects
- Housing already under Construction or Complete



For more information or to obtain a quotation go online at

[WWW.BUILDZONE.COM](http://WWW.BUILDZONE.COM)

or Call the Build Zone Team on

0345 230 9873



**Superglass**  
see them on.....II



**Quickscale**  
see them on.....III



**Premier Guarantee**  
see them on.....XII - XIII



**Fireglass**  
see them on.....IX



**Invista**  
see them on.....XVI

## Build-Zone: 10 year structural warranty provider

**B**uild-Zone is among the UK's top suppliers in underwriting warranties for all structural developments.

Build-Zone benefits from being a trading style of Sennocke International Insurance Services which was established in 1990, which has allowed them to develop over 28 years of experience, understanding the importance of providing support throughout the building process.

Build-Zone provide exceptional service from

their in-house technical services facilitating company called Build-Zone Survey Services (BZSS), that use a network of independent, qualified surveyors and approved inspectors.

As one of the top names in the industry, Build-Zone showcased their services at Ecobuild 2018, which took place at ExCel London on 6-8 March 2018.

Renowned as the built environment leading event, the show brought together professionals from across the industry for

two days of discovery, presentation and discussion. Here Build-Zone demonstrated their services, impressing attendees and industry peers alike.

Attendees were awestruck by Build-Zone's extra-services, which included construction insurance and Japanese knotweed insurance, as well as a vast range of technical services including EPC test and pressure testing.

**T 01732 749553**  
**www.build-zone.com**



## Superglass: Your roof, wall, floor & loft insulation provider



**S**uperglass is one of the leading suppliers of innovative and reliable insulation services, providing industry-leading thermal, acoustic and fire insulation.

The company was first established back in 1987 in Stirling, Scotland, which still remains its primary manufacturing site, a site which has been manufacturing mineral wool since the early 1950s. The company has since grown from strength to strength, and as one of the strongest innovators in the insulation market, they created the world's first Multi-Roll in the 1990s. The Multi-Roll is made of perforated mineral wool product, with the perforations enabling the installer to choose an appropriate width for a bespoke installation.

Superglass also developed blown solutions for retro-fit use in cavity walls. By 2005, they were already the UK's biggest independent manufacturer of glass mineral wool insulation.

Today, Superglass is one of the most well-known manufacturers of market glass wool insulation. They produce this from 84% recycled glass, a feat which reduces waste disposal and saves on valuable resources. Superglass products can be used in everything from walls to roofs to floors and caravans or park homes. Better yet, they are simple and easy to install.

The glass mineral wool is made through a highly complex and delicate process, whereby recycled glass is heated to extremely high temperatures. The glass is then spun, with silicon added to it to form a flexible fibrous mat that can be turned into the final end products. The glass mineral wool also restricts noise transfer, improving the acoustic performance of the walls.

Superglass' products are all non-combustible, with glass mineral wool even providing effective in-built fire protection.

**T +44 (0)844 381 4022**  
**www.superglass.co.uk**

## 1ST FOLDING SLIDING DOORS LTD

[www.1stfoldingslidingdoors.co.uk](http://www.1stfoldingslidingdoors.co.uk)



Sliding Folding Doors are a national company, that supply and/or install specialist concertina style doors. We have our own in house fitting teams to ensure the installation is carried out with the minimum disturbance.

Alternatively, we can supply doors and you can arrange for the installation to be carried out yourselves. We can arrange a free site survey to offer advice on designs and will follow that up with a quotation with no obligation to yourselves.

- ▶ High Quality Folding Sliding Doors
- ▶ British, German & Belgium Designed
- ▶ A Fantastic Variety of Finishes & Colours
- ▶ State-of-the-Art Security Features
- ▶ Free Survey & Design Advice.

For more information, or to arrange a no obligation appointment, call or email us today  
**0208 997 2448**  
**general@1stfoldingslidingdoors.co.uk**

**1ST FOLDING SLIDING DOORS**



**T: 01977 680250**  
**F: 01977 680284**  
**E: orders@tuffwaterproofing.co.uk**



TuffStuff® is the UK's premium designer, manufacturer and supplier of heavy-duty GRP waterproof flat roofing systems.

From our bespoke premises in North Yorkshire we supply our products through a dedicated Stockist network located throughout the country.

TuffStuff® has a dedicated product development team that work closely with customers and our own UK based manufacturing facility to produce an evolving product range that is suitable for multiple flat roof applications.

Please visit [www.tuffstuff.co.uk](http://www.tuffstuff.co.uk)



## CABLETRAIL CABLE MANGEMENT INNOVATION



**Tel: 01423 611610 • Email: enquires@cabletrail.com • www.cabletrail.co.uk**

## Leaders in Take Off Software

**B**uilding Update is proud to announce that QuickScale has been awarded the highly prestigious Measurement and Take Off Software of Choice Award 2018, for its services to the building and construction industry.

QuickScale is the UK's leading software specialist in taking measurements and areas off PDF drawings. Established in 2010, QuickScale offers simple to use and cost effective software. It calibrates the PDF by taking the scale of the drawing or a reference measurement. The user then clicks on the points and corners of the measurements & areas on the drawing and QuickScale will calculate their dimensions. The innovative software was originally invented for the high demand of the building and construction industry, but as years have passed it has become popular within the ship building and marine insurance industries, event planning, CCTV

and communications, as well as contractors and subcontractors. QuickScale is capable of working with drawings provided in a number of different mediums, whether they be via emailed drawings, scanned documents, photos, maps, etc. saved as PDF or other image format. Not only that, but it can then provide clients with measurements in either metres, millimetres, feet, inches, miles, kilometres or even microns if need be.

The QuickScale software offers over a handful of great benefits, including: no need to visit the site, no paper drawings being needed, Internet access is not required, QuickScale licences last forever and are not renewed annually, individuals are able to print on A4 to A0 plotters, all updates are free, help and support



is free and available on hand 24 hours a day and there is a free viewer in which clients can view and print their drawings with QuickScale measurements, without needing a QuickScale licence. Based in Harold Wood in Essex, the company currently provides QuickScale to contractors, subcontractors, quantity surveyors and architects in over 25 countries and ever continually expanding their global footprint.

Given the cost-effective and time saving benefits of QuickScale, not to mention how accurate the measurements from 2D drawings are, it is easy to see why QuickScale have been seeing rapid success with every new market and country it enters. In addition to slashing measurement time, it is also proving wholly cost-effective as clients need no longer spend

large amounts of money on sophisticated but costly CAD software, plotters and large format printers. They no longer have their PDF's printed to scale at a print shop. Many of their positive testimonials received include: "I have tried almost every PDF take off software on the market and QuickScale is by far the simplest and easy to use out there," said Andrew Brennan from Brennan Building & Civil Engineering Ltd. And Ian Hewitt from East Midlands Civil Engineering said, "I wish QuickScale was around 10 years ago. I can now measure in one day what usually takes a week!"

**T +44 (0)7791 550167**  
**sales@quickscale.co**  
**www.quickscale.co**  
**For a free 30 day trial, visit:**  
**https://www.quickscale.co/trial.html**

DESIGN • ENGINEER • FABRICATE • INSTALL



## STRUCTURAL INSULATED PANELS

We at SIP Hus have been in the SIP construction industry for over 14 years. This positions us as one of the countries most experienced SIP construction companies.

Mike Burke (MD) obtained a BA Hons degree in environmental design at Portsmouth University and after living in London and Bristol moved to Cornwall in 2003. Having worked with, and introduced other companies to SIP construction, at the beginning of 2016 Mike decided to set up his own company.

To achieve the high standard of service we strive for we continually monitor and improve on all aspects of the build process.

**Design – Engineering – Fabrication – Procurement – Logistics – Installation – Completion**

- Reviewing and revising design/engineering details to simplify fabrication and accelerate installation
- Reviewing whole market costs to maintain the best value for money
- Maintaining high levels of health and safety
- Client feedback on performance to hone our onsite installation
- Training and qualification within the construction industry and more specifically SIP installation
- Above all to deliver a high quality product within a specified time frame

[www.sip-hus.com](http://www.sip-hus.com) | 01209 215663 | [info@sip-hus.com](mailto:info@sip-hus.com)



## EE Ingleton



**E**E Ingleton have completed further projects using their new PicPer<sup>®</sup> image perforation system. Using the new software, anodised

aluminium panels were manufactured for Thames Architectural, and installed in Berkeley Homes Victory Pier luxury apartment development in Gillingham, as well as for ambulance bay screen panels at University College Hospital in London. Both projects called for very high open area panels to meet ventilation requirements, whilst retaining striking images and patterns.

The Victory Pier panels feature seven different waterbirds along the car park frontage, whilst the UCL installation was based on the architect's 'funky trees' concept.

The PicPer<sup>®</sup> system is proving highly effective where designers require a visually striking and unique installation, and has been used for a number of prestigious projects including Debenham's flagship Oxford Street store for Dane Architectural and Kingston's Riverside development in Kingston upon Thames for Cadisch MDA. The Kingston Riverside panels were based on a scenic photograph and also a classic motion study by the Victorian photographer Eadweard Mybridge. The Project Lions perforated panels & embossed soffit panels were based on a classic French Lace pattern.

In both these projects, the panels have been LED back-lit to stunning effect, whilst the panels for the Victory Pier & UCL projects were designed for effect in natural light.

**T +44 (0)114 275 7834**  
**sales@eeingleton.co.uk**  
**www.eeingleton.co.uk**

## UK's Most Innovative Supplier of Perforated Image Panels



**E**E Ingleton have been recognised with another innovation award for their perforated panel products, this time as the 'Most Innovative

Supplier of Perforated Panels' at the Build 2018 Construction and Engineering Awards. The new award comes as the company have recently completed further projects using their PicPer<sup>®</sup> image perforation system. Using the new software, more than 3,500 sq metres of decorative aluminium panels were manufactured for Laing O'Rourke's major upgrade of Meadowhall for owners British Land in Ingleton's hometown of Sheffield.

Laing O'Rourke's Project Leader, Mark Lazenby said, "EE Ingleton have proved to be an invaluable part of the LOR team, delivering high quality bespoke perforated cladding here at Meadowhall. As a local SME, their extensive engineering knowledge and manufacturing skills proved crucial in turning complex architectural conceptual designs in to engineered reality. Their collaborative and early inputs into the product design significantly improved and optimised both the pattern design and the manufacturing process delivering a final product which met the architects demanding concept."

With the increasing success of the PicPer<sup>®</sup> system and a number of ongoing new projects, the company are adding to major investment in plant made over the past 5 years, now installing further capacity with the addition of a new generation state of the art Trumpf perforating machine in their Sheffield facility, which is the first of its type in the UK.

Ingleton's are currently working on a number of new projects using the PicPer<sup>®</sup> system, ranging from small artwork installations to large public buildings.

**T +44 (0)114 275 7834**  
**sales@eeingleton.co.uk**  
**www.eeingleton.co.uk**

## New from Trim Acoustics Resound Acoustic Board



Suitable for wall and ceiling applications. The 22mm thick board provides high performance airborne noise reduction in an easy to handle size. The board incorporates a unique self adhesive jointing system.

High Density Mineral Wool  
 Resilient Bars  
 Timber Stud

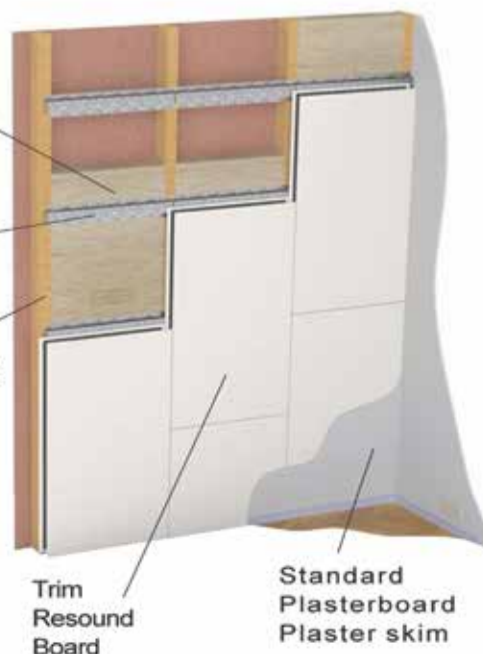

With more than twenty five years technical expertise and practical experience Trim Acoustics can offer a wide range of solutions

**Resound**  
Acoustic Board System



Just imagine feeling  
spoilt for choice.

You deserve a little luxury in later life. And it shouldn't cost the earth either... **Austin Heath is enviably positioned between the cultural hubs of Warwick and Royal Leamington Spa**, and offers a choice of **stunning homes from £227,000**, with your, very own wellness spa, bistro-café, landscaped gardens, village concierge and maintenance team, plus care and support as and when you need it.

**This is more than luxurious. This is Inspired.**

Call **01926 683 519**

[www.austinheath.co.uk/sh02](http://www.austinheath.co.uk/sh02)

Gallagher Way, Warwick, CV34 6AF

**Austin Heath**  
*Inspired* in Warwick

## Your Insulation Team



Superglass Insulation was founded in Stirling, Scotland, in 1987. The company has always been at the forefront of innovation, being the first to introduce Multi-Roll in the 1990s. In 2005, Superglass became UK's biggest independent manufacturer of glass mineral wool insulation, and in the last year were acquired by TechnoNICOL, one of the world's largest construction material manufacturers, providing a strong base for future expansion.

Superglass' figures have grown significantly over the past year with the help of the increasing housing market and the high demand for improved energy efficiency. Superglass is always finding ways to improve products for their clients and customers. Fire protection is one of their strengths as they offer non-combustible classified materials; the insulation has received the highest rating for a Reaction to Fire A1 (non-combustible) when tested against BS EN 13501-1.

Their products not only benefit customers with strong, high-performing insulation, but benefit the environment too. Superglass is proud to say that they recycle most material,

including waste glass, which helps bring down fuel bulks. Their glass mineral wool reduces heating and cooling, allowing them to save the energy used in sourcing raw materials, manufacture, distribution and installation.

Superglass' mineral wool is made from 84% recycled glass which reduces the amount of waste produced and was awarded with a 'Generic BRE Green Guide rating' of an A+. As one of the leading insulation companies in the UK, and supported by fresh investment by new owners TechnoNICOL, Superglass has delivered strong commercial growth, even in the current financial climate. Superglass focuses on the needs of their customers and

clients by forming a close bond, always ensuring service and satisfaction are their top priority, even offering additional technical support and advice on how best to install the insulation and optimise its effects.

Superglass' product range includes glass-wool insulation for almost any application within a build project. Their short term plans going into the future include continued growth in export markets, while continuing to build their customer base in the UK.

T +44 (0)1786 451170  
www.superglass.co.uk

## Fire Safety News

### International Passive Fire Ltd



A family run business, headed by Steven Bryant, International Passive Fire Ltd was established over 35 years ago and boasts of over 60 years combined experience in the industry. They are the leading independent stockist and specifier of passive fire protection products and coatings for the UK's and Europe's biggest manufacturers, including FSI, Jotun, Sherwin Williams, Eco-Sol, Exiitle, Boss Door Controls, Watco Floor Coverings, and Sika to name a few.

International Passive Fire Ltd are proud to be the main UK importer and distributor for the Sika Pyroplast Wood T and Wood W range of intumescent coatings for timber, offering a Euroclass B-s1 d0 fire classification on softwood 10mm thick or greater with a density of 400kg/m<sup>3</sup> or greater, and 12mm thick or greater on composite wood with a density of 600kg/m<sup>3</sup> or greater.

Pyroplast Wood T is a high clarity clear intumescent coating designed to offer exceptional finishes and performance to your internal timber cladding with minimum fuss on application and specification.

Pyroplast Wood W and T have been put through rigorous testing to EN 13823 and EN 11925-2, each product has a 'Classification of Reaction to Fire' report in accordance with EN 13501-1, these reports are available upon request.

Further details can be found on the brand new stand-alone website www.pyroplast.co.uk dedicated solely to the Pyroplast range, with data sheets and brochures available to download from intumescent and fire retardant coatings for steel, timber, fabrics and plastics, collars and wraps, intumescent fire and smoke door seals, sealants, batts and mastic, loft and access hatches, fire door upgrades, fire rated ironmongery, and door closers, to fire barriers and curtains.

Customer service is at the forefront of the business, expertly serving their loyal customer and client base ranging from small, independent companies all the way to some of the most renowned construction companies in the UK and overseas.

The Passive Fire Protection industry has become one of the most exciting and fast growth industries to be involved with. International Passive Fire Ltd strives to become the go-to company for Passive Fire Protection material and specification services. Their knowledge base is continuously expanding on a daily basis with new EN tested and CE certified products being introduced weekly.

M +44 (0)1752 690997  
sales@fireproofpaint.co.uk  
www.fireproofpaint.co.uk

**Omega** | windows & doors™

Manufacturers & installers of quality UPVC Windows & Doors



Conservatories  
Patios & Bi-Folds  
Soffits & Fascias  
Small Building Works  
Orangeries

Specialising in flush facing sash windows



Unit 9, Alfred Street South  
Nottingham NG3 1GE

T: 0115 761 7982

E: omeganottingham@outlook.com

ROSSO MANIGLIE  
ELEGANZA CON STILE



### FINE ITALIAN DESIGN

Rosso Maniglie is our exclusive range of Italian inspired designer levers. Produced using a zinc base material and manufactured to the highest standards, this range takes designer levers to the next level.

Created with a sleek and incomparable aesthetic appeal, our contemporary style Rosso Maniglie range has quickly become the first choice for home owners, architects and house builders throughout the UK.

T : +44 (0) 1228 672 900  
E : sales@zoo-hardware.co.uk  
W : www.rosso-maniglie.co.uk

For further information on this range visit our website or call one of our friendly sales team.

RMSQ080CP  
Maia lever on square rose with

RMSQ004CP  
Turn & release on square rose

Rosso Maniglie is part of Zoo Hardware Ltd. ZOO

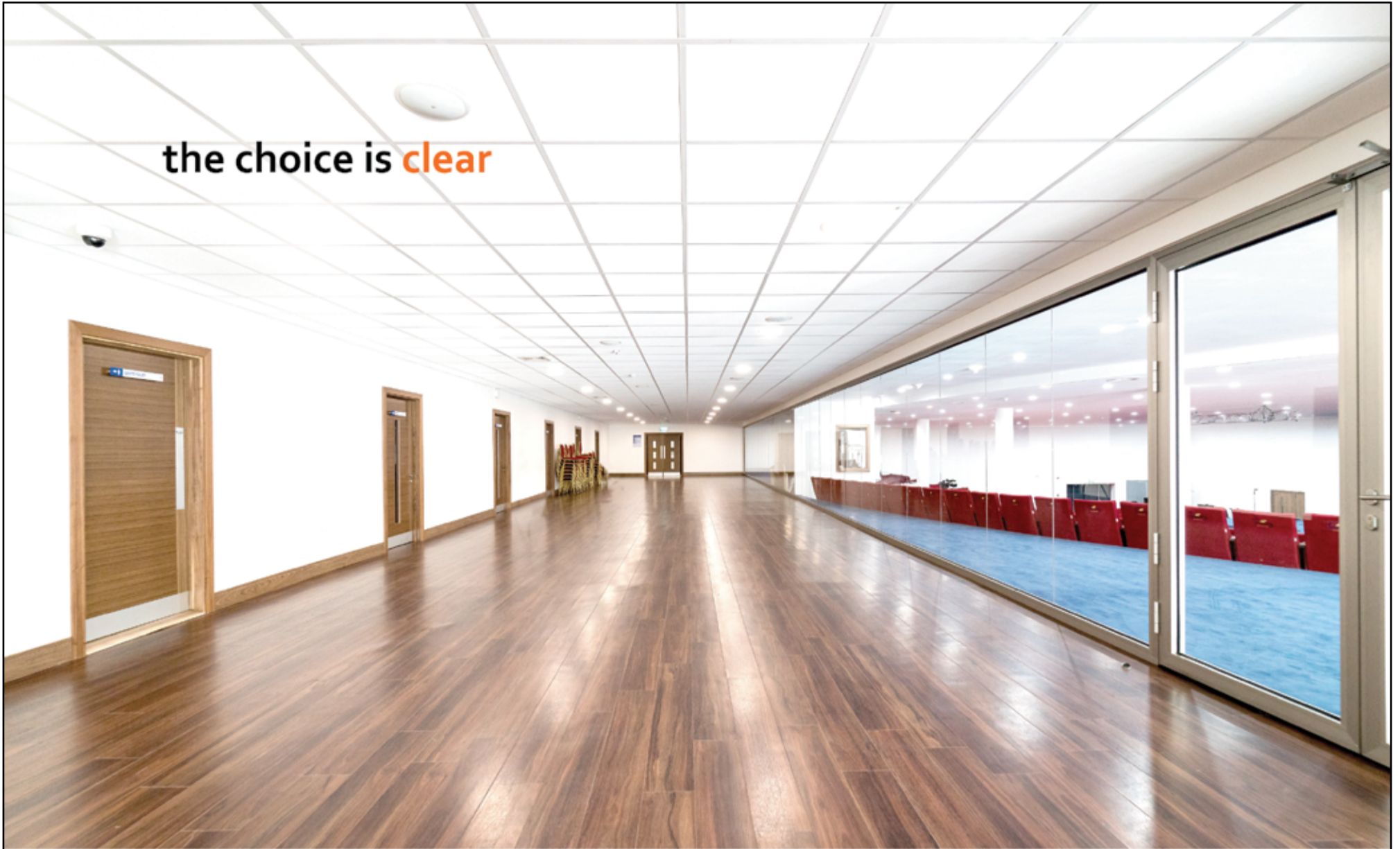

the choice is clear

Your designs are unique, expressing your creativity and style.

An ethos that has never been so clearly defined than with our fire resistant Vision Line range of frameless glazing solutions, designed to unlock your interior spaces and transform the dynamics of building interiors.

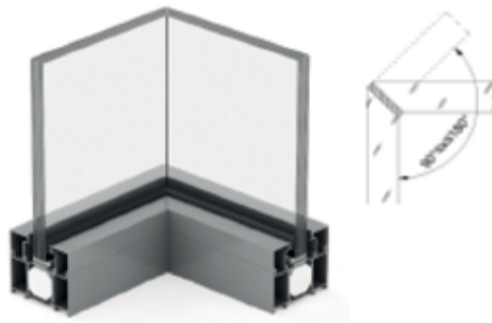

"pane-to-pane" angle connection

Insulation has been built in with this EI rated system offering protection against flames, smoke and heat. Furthermore, the Alufire range has achieved the LPCB certificates LPS 1158 and LPS 1056 as standard.

Oozing with style and sophistication the range can be arranged in a wide range of configurations, including glass-to-glass corners, slimmer profiles and unlimited length of glazed walls.

But it doesn't end there, we can accommodate unusual shapes and configurations to suite buildings from contemporary architectural designs to historical buildings.

Call: 01279 850021

email: [info@checkmatefire.com](mailto:info@checkmatefire.com)



[alufire.co.uk](http://alufire.co.uk)

Find us on:



# Renowned Fire Door Manufacturers

UK Fire Doors Ltd was first established in 2013 by Tim Askew. Based in Wales, the company have two sites which specialise in manufacturing certified and pre-hung fire doors, acoustic doors and security doors for a wide variety of clients and markets including hospitals, schools, commercial clients, the retail sector and more.

The company uses a computer controlled manufacturing process that is combined with traditional craftsmanship including hand-stitching, book matching of veneers and individual product

inspection. The company offers a choice of over 300 veneers which enables each fire door and acoustic door to be as unique as possible.

Fire Doors supply door sets for the commercial construction market. Third party certified solutions are supplied for sectors such as health, education, accommodation, encompassing fire, acoustic, security and extended performance criteria's.

Fire doors are committed to following standards and sustainability, which is why they follow certification



standards such as IFCC, Q Mark and FSC. Offering coverage all over the UK with operating

sites in North Wales and the East Midlands, Fire Doors has the largest capacity of all UK manufacturers and they distribute to projects all across the country.



The acquisition of Leaderflush Shapland site based in Langley Mill, Derbyshire, allowed them to grow significantly, the company now proudly boast their exemplary services across 200,000 sq ft of manufacturing capability.

Fire Doors aim is simple, "to be the UK's door set market leader by being the benchmark for service, quality and value." They continue by saying, "being customer driven, employing and training the best people in the industry and continually improving their systems to deliver on time and to specification."

Customer service is at the heart of the company which is why they pride themselves in giving the best service to all of their customers and clients. Fire Doors offer specification support, where at the design stage, they will offer on-hand advice on how to combine performance requirement with a door set aesthetic, configuration or even ironmongery suite.

Other services they provide are value engineering for customers that need assistance in exploring cost-effective options as well as needing to meet performance criteria, expedited delivery where the company operate from two sites in the UK to support customers working to tight handover dates and consultancy, where Fire Doors technical engineers can visit sites to deal with any post installation issues, which ranges from problem resolutions to FM advice.

One of Fire Doors new and highly sought-after ranges is the V Line range, which is of a high-quality and offers premium finishes at great prices. This range is produced at the Langley Mill factory, where architectural, grade veneers are used.

Features and benefits of this range include the following: being manufactured in the UK, has real wood veneers with hard lipping on all four edges, robust build with its three-layer particleboard construction, metric standard sizes, as well as being fully certified and being dispatched quickly for fast delivery. The range is available in a range of finishes such as RAL 9010 full white paint, American White Oak, ash, white,



polar white and dove grey or charcoal laminates.

The company attend exhibitions as visitors such as London Build and Eco-Build. They exhibit at FireX where they have the opportunity to showcase their wide range of products and services to new potential customers and clients, as well as being given the opportunity to be involved in new projects.

For further information or general enquiries, visit the Firedoors website. Alternatively, you can contact the company via telephone or email.

T +44 (0)1244 551360  
sales@firedoors.co.uk  
www.firedoors.co.uk

## FIREDOORS

YOUR FIRST CHOICE FOR PERFORMANCE DOORS & DOORSETS

introducing...

# Endurodoor ECO 30



- The first performance door proven to help protect the quality of the air we breathe.
- E0 rated due to our unique 'Zero Added Formaldehyde' production process.
- Suitable for hospitals, schools, care homes and all types of commercial/residential application.
- Engineered to last and designed to perform.

Why choose anything else?

**Endurodoor** - Exclusively available from Firedoors, the UK's largest manufacturer of performance doors and doorsets.



**FIREDOORS**  
Bryn Mawr Industrial Estate  
Pinfold Lane • Alltarn  
Flintshire CH7 6NZ

**01244 551 360**  
sales@firedoors.co.uk

[www.firedoors.co.uk](http://www.firedoors.co.uk)

FIREDOORS is the trading name of UK Fire Doors Limited.

RESIDENTIAL

EDUCATION

MEDICAL

COMMERCIAL

## Firebreather cavity fire barrier with instant fire stop



**S**ECURO manufactures the award winning Firebreather cavity fire barrier that is the only fire barrier with instant fire stop on the market. This makes it the safest cavity barrier to prevent fire from spreading behind façades.

Securo are a Norwegian based company and are at the moment established in 9 countries. We produce passive air transfer grilles and cavity barriers that ensure the necessary ventilation while it instantly blocks the spread of fire. All products have EI rating, requires no activation and has no detectors or moving parts. The products have won numerous awards for its innovative technology.

Our organisation includes fire advisers, product designers, sales department, administration and production with great expertise in their fields

both nationally and internationally as well as a very active and experienced board of directors.

SECURO has a policy of transparency and have all of our test results and approvals openly available. Our main objective is to be the leading manufacturer in our field and to provide the best possible service so all our customers can feel safe with our solutions. We shall provide a simple, flexible and affordable way to meet the government requirements for fireproof ventilation solutions. We are actively seeking a sales partner in the UK.

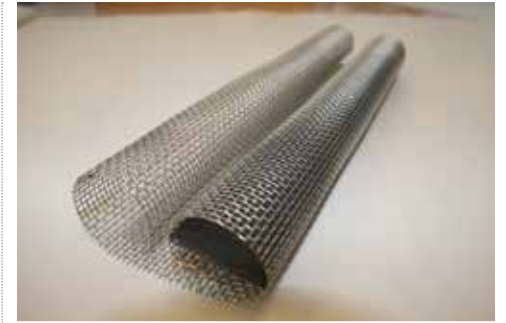

Contact  
rotvoll@securo.no  
www.securo.no

## FDS wins Paddington Gardens contract



**F**ire Design Solutions (FDS) has secured its latest contract to supply smoke ventilation and corridor environmental systems to the new Paddington Gardens residential development. The award-winning fire safety systems contractor will provide full consultation, design and installation services.

Paddington Gardens, which occupies a 3.8 acre site within London's Paddington Waterside regeneration has been designed by award-winning Assael Architecture. Also working on the project are Powell Dobson Architects, acting for the client in the delivery of the scheme. When completed, the four residential towers will comprise one, two, three and four bedroom apartments and penthouses with views of the surrounding landscaped gardens and London skyline.

The Paddington Gardens project is the latest in a series of collaborations between FDS and Ark M&E over the last five or more years. FDS was engaged early on, and has been providing consultancy on the design for the development's fire safety features.

The contract includes the supply and installation of residential smoke ventilation and corridor environmental systems up to 21 levels in each block, as well as the basement car park and loading bay smoke ventilation system. During the design phase FDS was able to make recommendations to help optimise the layout of the building by planning the systems in the most efficient way for example, combining the loading bay and car park ventilation systems.

Contact  
T +44 (0)1322 387411  
info@firedesignsolutions.com  
www.firedesignsolutions.com

### FIREDOORS

YOUR FIRST CHOICE FOR PERFORMANCE DOORS & DOORSETS

Market leading in:-  
Fire doors and doorsets  
Sound attenuation doorsets  
Secure By Design PAS24:2016 sets  
Full third party certification

Please contact [www.firedoors.co.uk](http://www.firedoors.co.uk)  
Tel: 01244 551360 | [sales@firedoors.co.uk](mailto:sales@firedoors.co.uk)



## EXTERIOR FIRE PROTECTION

SECURO manufactures and sells passive air vents that ensure the necessary ventilation while it instantly blocks the spread of fire. The vents require no activation and have no detectors or moving parts.

### OUTSIDE FIRE SPREAD

Outside spread of fire caused by sparks and embers flying through the air is a major problem and accounts for more than 50% of all external fire spread. Where it was previously mostly focused on fire spread between buildings through the radiant heat, we are now also more aware of the fire spread from hot particles carried in the air. The biggest problem with spread of outdoor fires is the combination of sparks and wind that causes fire to go into the house through cavities and weaknesses in the construction.

### FIRE PROTECTIVE ENVELOPE

The fire protective envelope is the outer layer of the construction where openings

and cavities in roof, eaves and gables and cladding are critical areas for the spread of fire. This is an important area to maintain adequate venting into the construction and at the same time critical areas to protect from fire spread. The solution to this is to secure these weak points to achieve a closed fire protective envelope and delay or stop the spread of fire.

### FIRE IN CAVITIES

Fire in a cavity spreads very quickly and can burn with a rate of 2-8 m/sec. This is because of the different density between hot and cold air makes the hot gases rise up in the cavity.

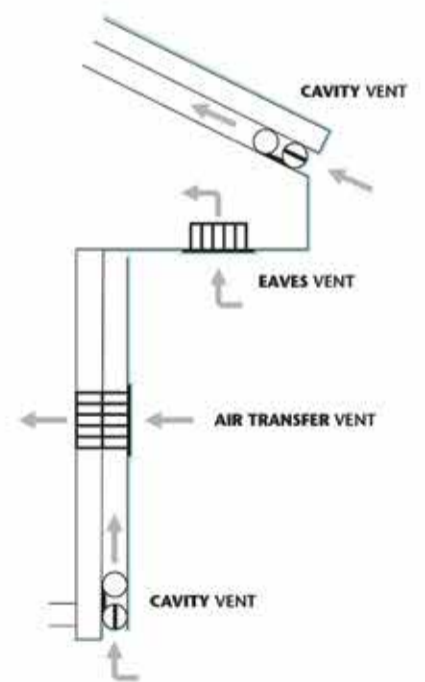

**FB** Firebreather<sup>®</sup>  
by Securo

SECURO AS • Neptunvn. 6 • 7652 Verdal Norway  
+47 99 41 90 00 • [post@securo.no](mailto:post@securo.no)

[www.securo.no](http://www.securo.no)

**SUPER STRONG HOLD**  
Will stick just about anything on a building site!

**GRAFT**  
SOLVENT FREE ADHESIVE  
**GRAB ADHESIVE**  
SOLVENT FREE ADHESIVE  
SUPER STRONG  
HIGH PERFORMANCE POLYURETHANE

01484 421036 | [www.graft.co.uk](http://www.graft.co.uk) | [/GraftSealants](#) | [@GraftSealants](#)  
Developed & manufactured in the UK by POLYSEAM LTD.

THE UK'S ONLY CHOICE FOR FIRE RATED & OTHER SPECIALIST GLASS

FIRE RATED, ACOUSTIC, LAMINATED, TOUGHENED, IGUS, HERITAGE UNITS, SILVERED GLASS

A SPECIALIST CUT-SIZE SERVICE FOR GLASS PARTITIONS

INTEGRAL BLINDS IN IGUS

FAST DELIVERY FROM FIVE NATIONWIDE BRANCHES

10 YEARS IN BUSINESS

LET US HELP YOU ON YOUR NEXT PROJECT  
01215212180

**Fire Glass**  
UK

HEAD OFFICE 0121 521 2180  
MANCHESTER 0161 728 8080

DERBY 01773 712 920  
COLCHESTER 01206 222 090

EDINBURGH 0131 526 4141  
INSTALLATION 0121 521 2180

[WWW.FIREGLASSUK.COM](http://WWW.FIREGLASSUK.COM)  
SPECIALISTS IN FIRE RATED GLASS & GLAZING



## Fire Engineering Solutions from FDS

Do you feel inhibited in what you can design and build due to regulation? We offer fire engineering services at either the design, build or install stage of the project, which help you to reach your design ambitions whilst adhering to strict fire safety standards. What's more, our value engineering expertise also ensures that you maximise rentable space, enhancing the building's profitability.

Our team of fire engineers has unrivalled experience, working on amazing projects such as Langham Square, Tesco's, The Place, London Bridge (mini Shard), Corinthia Hotel, Langham. Whatever the project, no matter how big or complex, if it's subject to fire safety regulations FDS can provide a full range of fire engineering solutions and services to answer any need.



More information, please visit [www.firedesignsolutions.com](http://www.firedesignsolutions.com)

Do you want to have creative freedom to design and construct the buildings you want whilst sticking to regulation and enhancing profitability? Call Fire Design Solutions on **01322 387411** or fill out a contact form today and tell us about your project.



fire design solutions

# Peter Minter: The Brickmaker's Tale



The Bulmer Brick & Tile Co Ltd

**P**eter Minter and his son Tony are well-known for their father and son business, Bulmer Brick and Tile. The family-run business has successfully been running for over 80 years and is extremely proud to say they have excellent expertise and knowledge in this industry.

Peter Minter wrote his own book, *The Brickmaker's Tale*, which entails a unique history of the Bulmer Brickyard and the craft of brick-making. Bulmer Brick and Tile pride themselves in saying that they are the most traditional in the UK that still uses methods to make bricks which

dates all the way back to 1450. The first section of *The Brickmaker's Tale* focuses on the early history of the site, the second part of the book explores from 1936 onwards when the Minter Family acquired to the company.

Finally persuaded by family and friends, Peter Minter wrote a book that recorded some of his unique knowledge and memories in a book. The book highlights the story of the Brickyard and the people that have worked there throughout the years. It also mentions some of the fascinating projects that Mr Minter's family have worked on.

*The Brickmaker's Tale* touches on the recreation of historic bricks for National Trust properties which include Hampton Court Palace and Blickling Hall in Norfolk, not to mention the bricks for the extension of St Pancras Station in London.

The process of making bricks starts from

digging a year's supply of clay from a specific hill each autumn, it is a job that takes nearly two weeks, with each cubic meter forming into a thousand bricks. The book includes fine details such as the importance of slight imperfections as this is what makes the characteristics of the bricks, such as odd ridges, folds and an occasional small stone.

The process continues by stacking clay loaves to dry and for bricks to lose their sulphates, and approximately after a week, they will have shrunk slightly as the water content has been reduced, they are then fired in a kiln.

*The Brickmaker's Tale* is available from local bookshop Kestrel in Sudbury Suffolk or direct from Bulmer Brick & Tile Co Ltd. For further information or general enquiries about Bulmer Brick and Tile, visit the company website. Alternatively, you can contact Bulmer Brick and Tile via telephone or email.

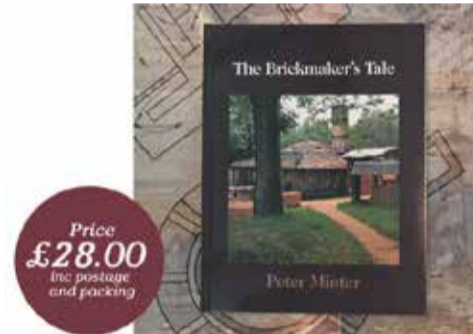
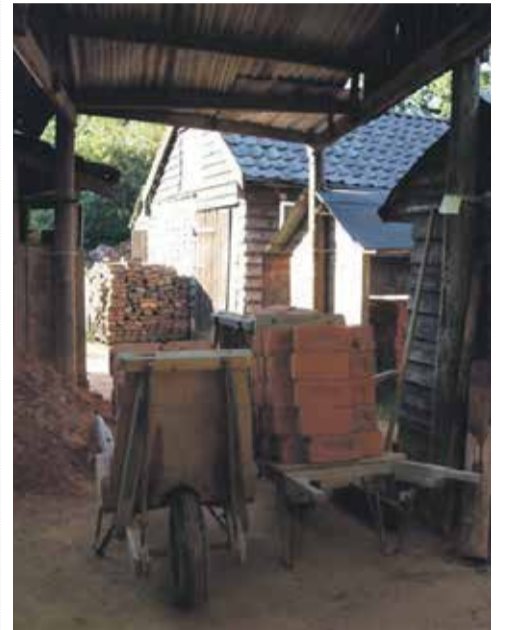

T +44 (0)1787 269232  
 bbt@bulmerbrickandtile.co.uk  
 www.bulmerbrickandtile.co.uk

The Bulmer Brick & Tile Co Ltd



Bulmer Brick and Tile Company is a long established family business on the site of a brick making yard dating back centuries. Bulmer bricks are made from the finest London Clays, dug continually from our own clay seams since Tudor times. All our bricks are entirely hand made using traditional methods. We specialise in restoration and conservation of old buildings; working closely with architects and contractors to produce our facing brick to the specification required for your particular building. Although we aim to have a stock of the more common sizes, dimensions and texture are made to order, so that each building receives the correct brick for the work. The kilns are unique coal fired down-draught kilns, loaded, unloaded and fired by hand in a long and labourious process, ensuring each and every brick has had our personal attention. No artificial colours, tints or dyes are used in our process. The beautiful range of colours from orange to dark red and purple comes purely from the firing process, just as it would have been over the centuries.

We make a huge variety of brick specials, including terracotta, plinths, squints, decorative chimney bricks, string course bricks and over 500 different types of coping which increases on a weekly basis. All the specials are moulded from wooden moulds, which are made in our own carpentry workshop.

Please visit us at: [www.bulmerbrickandtile.co.uk](http://www.bulmerbrickandtile.co.uk)

Tel: 01787 269232 | Fax: 01787 269040 | Email: [bbt@bulmerbrickandtile.co.uk](mailto:bbt@bulmerbrickandtile.co.uk)

[teamworks]

Up to 84% recycled glass  
 Up to 100% better  
 for the environment

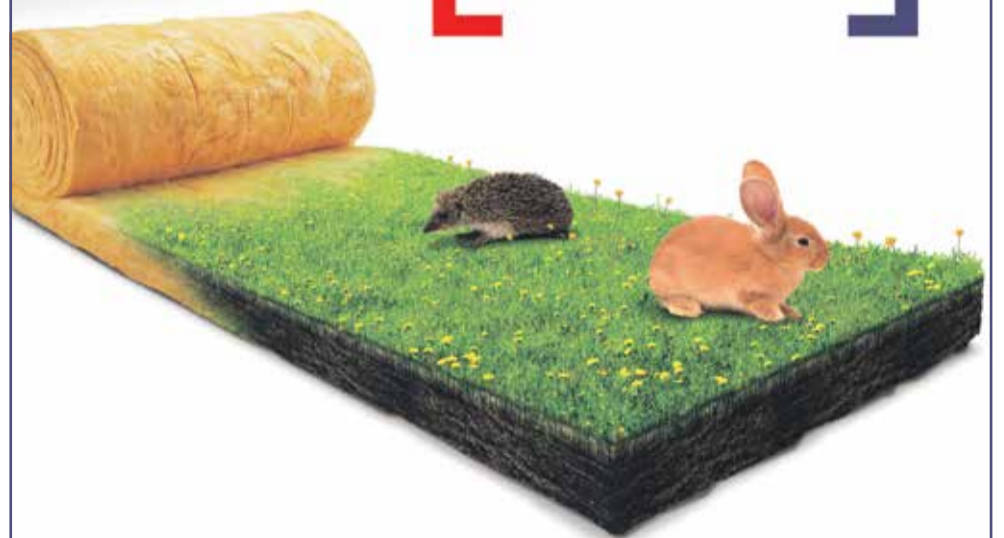

**Saving energy and saving time on your build project?**

Superglass high quality glass mineral wool insulation cuts energy waste. By using recycled glass, it cuts the amount of waste heading to landfill too. And with the flexibility to produce to your exact specification, Superglass even cuts installation time and cost on-site. No wonder it's the material everyone's warming to.

To find out more, call Superglass on 0844 381 4022 or visit [superglass.co.uk](http://superglass.co.uk)

Your insulation team  
**Superglass**  
 BBA APPROVAL  
 BRICKS  
 TILES  
 TERRAZZO  
 COMPACT  
 SLATES

Call 0844 381 4022 or  
 visit [www.superglass.co.uk](http://www.superglass.co.uk)

# CORDURA® and Carhartt: Latest collaboration addresses key work site clothing needs

New Carhartt Full Swing® Collection Harnesses the Power of Consumer Insights to Address Key Needs on the Jobsite.

CORDURA® brand and Carhartt announce the latest collaboration in their long-standing partnership with the launch of Carhartt's newest generation Full Swing® Steel line, a dynamic workwear collection designed and developed through an extensive consumer insight program.

The Carhartt Full Swing® Steel collection consists of a men's jacket, cargo pant, double-front pant and multi-pocket pant, incorporating multiple CORDURA® fabric technologies to deliver flexible, versatile, durable solutions for hardworking people.

"Our latest line of Full Swing® garments was built and inspired using years of jobsite visits and insights from our Carhartt Crew – carpenters, roofers, aircraft and diesel mechanics, landscapers, and engineers are just

a few of the occupations we reached out to," said Anne Rourke, design manager for Carhartt. "We worked with our Insights team and even used a crowd sourcing tool to help design and test products with the goal of creating the 'Ideal pant solution.' With the Crew's invaluable feedback on optimal ergonomics and functionality, we developed products such as our Full Swing® Steel Multi-Pocket Pant not only with extra rugged stretch CORDURA® NYCO fabric for mobile durability but also with additional CORDURA® fabric reinforcement in critical wear areas."



Engineered CORDURA® fabric technologies in combination with ergonomically placed kneepad pockets were incorporated to provide an enhanced level of comfort and protection. According to the Carhartt crew, "the material, knee pads, fit, flex and durability are amazing, and the pocket layout and reinforced areas were very well thought out."

"Our heritage with Carhartt continues to evolve as evidenced by this latest integration of consumer-insights and CORDURA® fabric technology to innovatively address unmet needs," said Cindy McNaull, global CORDURA® Brand and Marketing Director.

"The latest Full Swing® collaboration is a true testimony to our 20 years of continuous partnership.

"INVISTA's CORDURA® brand essence celebrates individual durability: As long as the world is full of durable people, we'll keep making durable fabrics™. Known for its resistance to abrasions, tears and scuffs, CORDURA® fabric is a primary ingredient in many of the world's leading high-performance gear and apparel products."

To learn more about the CORDURA® fabric + Carhartt collaboration, please visit [www.CORDURA50years.com](http://www.CORDURA50years.com) or [www.CORDURA.com](http://www.CORDURA.com) or join the story on Facebook, Twitter, Instagram, LinkedIn or YouTube.

**SWITCHABLE PRIVACY GLASS & FILM**

Specialists in Switchable Smart Film Installations

ON OFF

Simply retrofit switchable privacy film to your glass area and instantly control your environment via wall switch, remote or third party App

[www.sontefilm.co.uk](http://www.sontefilm.co.uk)

Email: [sales@sontefilm.co.uk](mailto:sales@sontefilm.co.uk) - Call +44 (0)7876 183063

**Nationwide Louvre Company**

Louvres / Plant Screening / Louvre Doors / Brise Soleil

**NLC QUALITY AND PERFORMANCE**

The Louvre Works, Units 5-7 Beacon Trading Estate, Middlemore Lane, Aldridge, West Midlands, WS9 8DU  
Tele 01922 457204 or email [sales@nlc-louvres.co.uk](mailto:sales@nlc-louvres.co.uk)

## Waste Management News

**enquiries@thehdgroup.co.uk | 01494 792000 | www.hdservicesltd.co.uk**

With over 30 years experience, we offer bespoke solutions for the domestic market throughout the South East. A free feasibility study can usually be determined upon receipt of a site postcode.

<p><b>WATER SUPPLY &amp; SOAKAWAY BOREHOLES</b></p> <p>An independent water supply for consumption* or garden irrigation and bespoke drainage solutions</p> <p>* subject to analysis and suitable filtration</p>	<p><b>RENEWABLE HEATING</b></p> <p>Reduce heating bills by up to 50%.</p> <p>Groundwater can be used as a heat source for an Open-Loop Ground Source Heat Pump, providing heating and hot water as required.</p>	<p><b>SEWAGE TREATMENT SYSTEMS</b></p> <p>Independent sewage treatment systems are specifically designed to meet the needs of individual clients.</p>
--	--	---

## Acoustic experts



Trim Acoustics was established over 30 years ago. Based in Huntingdon, Cambridgeshire, the company specialise in distributing acoustic material for some of the UK's biggest manufacturers such as Sound Reduction Systems and H&H Acoustic Technologies. The company are pleased to say that they have technical reps UK-wide and they have developed their own range of acoustic product suitable for floors, ceilings and walls which are available nationwide.

The company provide products for residential, commercial and industrial use. Trim Acoustics have a full range of products to fit all applications, which have all been tested to meet Building Regulations Document E and the company provides full technical back up UK wide through their team of reps.

The most recent product to join the Trim Acoustics range is their Resound Board. It has a composite design and has the ability to reduce sound resonance through wall and ceiling constructions, which have the overall result of reducing both airborne and impact noise.

Customer service is at the forefront of the business. Trim Acoustics proudly boast their loyal customers and clients that range from small, independent companies all the way to some of the renowned construction companies in the UK.

T +44 (0)208 443 0099  
[www.trimacoustics.co.uk](http://www.trimacoustics.co.uk)

premier<sup>®</sup>  
guarantee

# WE ARE TECHNICAL EXPERTS

Providing guidance  
and assuring quality

STRUCTURAL WARRANTIES AND  
BUILDING CONTROL FOR NEW HOMES

PREMIERGUARANTEE.COM  
0800 107 8446

MD Insurance Services Ltd is the Scheme Administrator for the Premier Guarantee range of structural warranties.  
MD Insurance Services Ltd is authorised and regulated by the Financial Conduct Authority.

premier  
guarantee®

# KNOCK KNOCK

We're not joking around...



WE JUST WANTED TO LET YOU KNOW WE  
HAVE COVERED OVER £57BN WORTH OF  
PROPERTY ACROSS THE UK AND EUROPE

Find your Structural Warranty Solution

[PREMIERGUARANTEE.COM](https://www.premierguarantee.com) | 0800 107 8446

MD Insurance Services Ltd is the Scheme Administrator for the Premier Guarantee range of structural warranties.  
MD Insurance Services Ltd is authorised and regulated by the Financial Conduct Authority.

## Your perfect getaway in the Midi Pyrenees



**F**or buyers looking for a property in the Midi Pyrenees, France, we've got a renovated 18th century stone house for sale.

The stone house is based close to the market town on Mazamet in the commune of Pont de L'Arn. Located in a hamlet, the semi-detached, south-facing stone house is going for just €260,000 and is fully renovated, boasting 7 rooms and a range of excellent facilities and amenities, including: kitchen, dining room, lounge, four bedrooms, four WCs, laundry, garden and garden terrace.

On the 150m<sup>2</sup> habitable ground floor there is the beautiful kitchen which boasts a wood stove, old beams and original granite slabs. The large kitchen is an off white, and comfortably fits a medium sized table, chest of drawers, cooker, two windows, and plenty of counter top space. Also located on the ground floor is the dining room, which features an original pine floor and built in antique cupboard. Perfect for family dinners, entertaining guests and much more, the dining room is roomy, spacious and with plenty of room to breathe, with double windowed doors facing the beautiful greenery of the outdoors.

The lounge features an old fireplace, wood stove and plenty of space for sofas, TVs and the like. All of the rooms overlook the stunning and picturesque 80m<sup>2</sup> terrace which can be entered onto through gorgeous French Doors.

Up on the first floor are plenty more rooms. There is a bathroom, a WC, and four bedrooms, one containing a private shower and WC. A fourth WC is found on the bottom floor of the laundry room.

The stone house features double glazing in all rooms on the ground floor, and even in one of the bedrooms. On top of that, there are numerous electric radiators spread throughout the house, as well as a storage heater on the landing, another storage heater in the dining room, two 200L electric hot water tanks, and on the landing is an Air-con unit for heat and cool settings.

Out on the terrace there is plenty of space for garden parties, BBQs and for the kids or pets to run around. There is a beautiful and serene seating area, lovely trees and foliage, and a spectacular view of the countryside and La Montagne Noire.

As for the garden, it covers 1,800m<sup>2</sup> and can be accessed via the terrace or via two sets of large gates from the road. With such a large open space, buyers can install anything they wish into the garden, whether it be a pool, Jacuzzi, basketball pitch, or more. In fact, the current garden already serves as the perfect football field if needed! The garden also contains a well for watering the garden or for filling a pool. Not only that, but the garden also contains an old 18m<sup>2</sup> stone outbuilding that is currently used as a workshop but is ideal for a number of different purposes and can be repurposed into most anything – an outdoor storage facility for example.

The stone house is also in the perfect location, with an airport, hospital and even golf course nearby. The nearby town of Mazamet is bursting with everything from restaurants to hotels, boutiques, supermarkets, parks and even a public swimming pool. Just a quarter of an hour outside of Mazamet is a mountain Lake that's perfect for swimming in July and August, and which even has life guards, mini golf and restaurants. And don't forget there is plenty more to explore in the Montagne Noire range.

If you would like to find out more information, please get in contact using the details below.

T 0033 563 619 556  
 judith81660@gmail.com  
[www.afranceproperty.com/France/Midi\\_Pyrenees/House/525](http://www.afranceproperty.com/France/Midi_Pyrenees/House/525)

### House in Mazamet Midi Pyrenees, Tarn

#### Description of House in Midi Pyrenees:

Beautiful 18th century stone house entirely renovated with 1,800m<sup>2</sup> of land. Close to Mazamet, a beautiful 18th century stone house, completely renovated and semi detached, located in a rural hamlet in the region of Arn Bridge.

All rooms are South facing overlooking a terrace of 80m<sup>2</sup> with magnificent views of the Montagne Noir Mountains. Double glazing is in all ground floor rooms and one bedroom.

### Property Sale

[www.afranceproperty.com/France/Midi\\_Pyrenees/House/525](http://www.afranceproperty.com/France/Midi_Pyrenees/House/525)



# GORRON



**Charming village house comprises of 3 bedrooms, bathroom, sitting room, study, dining room, kitchen and garden room. Stairs to fully floored loft space. Garage, utility room and a workshop. A large flower garden with fish pond and an orchard. Mains electricity and water. Wastewater to holding tank system.**

**€ 159,00 ono**



☎ 0033 2 43 00 60 72

[mikefraser@orange.fr](mailto:mikefraser@orange.fr)

www.amazonfilters.com

**FIRST CLASS SERVICE**  
**WORLD CLASS FILTERS**

Building Services Filtration Manufacturer

**Ask the Experts**

Protect your closed loop water circuits with an Amazon Side Stream filter system – the effective solution to eliminating contamination which can result in poor temperature control within the building and maintenance problems

The benefits of installing a Side Stream Filter System include:

- Ensuring effective building temperature control is maintained
- Preventing abrasive wear and tear on process plant
- Reducing time and lowering labour costs compared to a flushing regime

**AMAZON FILTERS LTD**  
Call +44 (0) 1276 670 600 or email sales@amazonfilters.co.uk

Find us on Social Media



## Side Stream Filtration ensures cleanliness of closed loop water circuits



**A**mazon Filters is a leading manufacturer of permanent Side Stream Filtration systems for initial clean-up and ongoing maintenance of closed loop water supplies to large buildings, airport/rail infrastructure and sporting/entertainment arena.

Once installed, the Side Stream Filtration system removes the contaminants from closed loop water systems – not only suspended solids but also the chemically treated biomass – and the problems that go with them. If left within the system these contaminants lead to poor temperature control within the building,

greater maintenance issues and unsatisfied users of the building.

The UK Building Services Research and Information Association\*\* recommends a permanent Side Stream filtration system as a key resource for initial clean-up and ongoing maintenance of water pipework systems.

An Amazon Filters Side Stream Filtration system is typically installed in the Plant Room of a building. A typical Amazon Filters Side Stream Filtration consists of an industrial style filter housing and SupaSpun II depth cartridge filters – one of the very few products to be accredited by the UK Water Industry for use in this specific application. Each Side Stream Filtration system is designed to treat 5-15% of the mains water circuit flow in a closed loop water circuit.

For the most effective filtration, Amazon Filters recommends absolute rated SupaSpun II cartridge filters as part of a side stream filtration system. These filters are available in a range of micron ratings, so as the re-circulating water becomes cleaner, a finer filter can then be installed to remove ever-smaller contaminants.

**For further information please contact Amazon Filters:**

**T +44 (0)1276 670600**  
**sales@amazonfilters.co.uk**  
**www.amazonfilters.com/**  
**applications/building-services/side-stream-system**



[www.yorkshiretimbereng.com](http://www.yorkshiretimbereng.com)

## We are the Leaders in Engineered Timber Frame Solutions

Established in 2008 by D.Prescott, S.Prescott, M.Bean and D.Grantley, Yorkshire Timber Engineering has seen significant growth in the years to follow. Its rapid progression has enabled the business to become one of Yorkshire's leading providers of roof trusses, engineered floor joists and timber frame solutions.

Whether it is a single story house or a six story apartment block, using our products greatly reduces the time required to complete the internal shell by up to 50% compared to traditional brick and block methods of construction.

With quicker build times, increased logistical efficiencies and greater cost controls, an increasing number of developers are switching on to our Timber Frame solutions.

### Why choose us?

We provide a second to none service and have operated extensively with clients from regional house builders and architects to individuals working on one off self-builds and extensions.

In fact, 95% of our business comes from repeat customers and through recommendations received from them.

For more information, please contact **01482 861213**  
Email **info@yorkshiretimbereng.co.uk**



**Snickers**  
WORKWEAR

**CORDURA**  
FABRIC  
LIVE DURABLE.

## THE TREND IN TROUSERS?

# A LOT OF MOVEMENT TO FLEXIWORK BY SNICKERS

Freedom of movement. That's what the Flexiwork range is all about – and there's plenty of it in these super-light, hardworking functional pants. This comes from their high-tech body-mapped garment design, and the fact that they're made with a special breathable stretch CORDURA® Naturalle™ fabric.

But this fabric offers far more than comfortable freedom of movement. It delivers an exceptional degree of durability with enhanced resistance to abrasion and tears. And for maximum toughness, Snickers have reinforced the knees, hems and pockets with rugged CORDURA® Classic fabric made with high tenacity nylon 6,6. The result is enhanced durability to add to the all-round comfort.

As for features, well here's a short version of the long list. Pre-bent leg design. Easy access pockets for all the everyday at work necessities like your phone that you need to keep on hand. And an integrated yet detachable hardwearing belt with an easy-to-close buckle that helps keep the pants just where you want them.

Plus, with the camo pattern prints, there's more than a touch of style to these trousers. And along with high-tech functionality, that's an important factor for the trade professionals who'll make these work trousers a familiar part of their daily life.

Which is exactly what you'd expect from Snickers. A company that's been driving the development of cutting-edge workwear for more than forty years, based on the real needs of skilled craftsmen who have to be able to rely on their gear.

To learn more about Snickers workwear, visit  
[WWW.SNICKERSWORKWEAR.CO.UK](http://WWW.SNICKERSWORKWEAR.CO.UK)

**CORDURA. LIVE DURABLE.™**

[CORDURA.COM](http://CORDURA.COM)



© 2016 INVISTA. CORDURA® and Live Durable™ are trademarks of INVISTA for durable fabrics.